

MS125

HYDRAULIC MOTORS



T E C H N I C A L C A T A L O G



CHARACTERISTICS

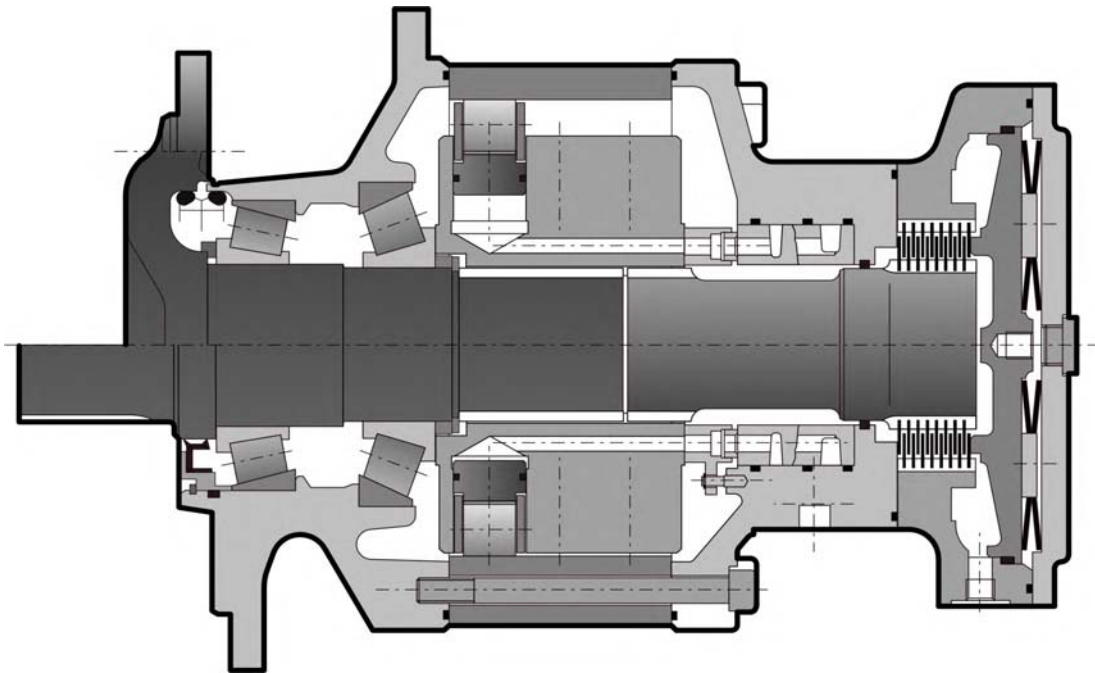

Motor inertia 3 kg.m²

	C	Displacement		Theoretical torque		Max. power *		Max. speed		Max. pressure bar [PSI]	
		1	2	1		1	2	1	2		
		cm ³ /tr [cu.in/rev.]	cm ³ /tr [cu.in/rev.]	at 100 bar Nm	at 1000 PSI [lb.ft]	kW [HP]	kW [HP]	tr/min [RPM]	tr/min [RPM]		
Cams with equal lobes	8	10 000 [609,9]	5 000 [305,0]	15 900	[8 086]	240 [322]	160 [215]	130	90	105	450 [6 527]
	0	12 500 [762,4]	6 250 [381,2]	19 875	[10 107]			105	70	85	380 [5 511]
	2	15 000 [914,9]	7 500 [457,4]	23 850	[12 128]			85	60	70	320 [4 641]
Cams with unequal lobes	A	12 500 [762,4]	7 500 [457,4] 5 000 [305,0]	19 875	[10 107]	240 [322]	160 [215]	100	65	80	380 [5 511]

- 1 First displacement
- 2 Second displacement



* For higher power value, please consult your Poclair Hydraulics application engineer.

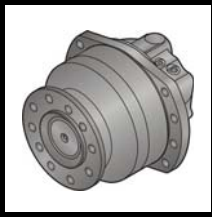
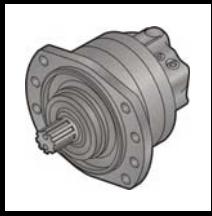
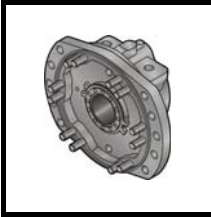
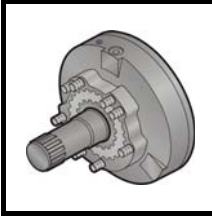
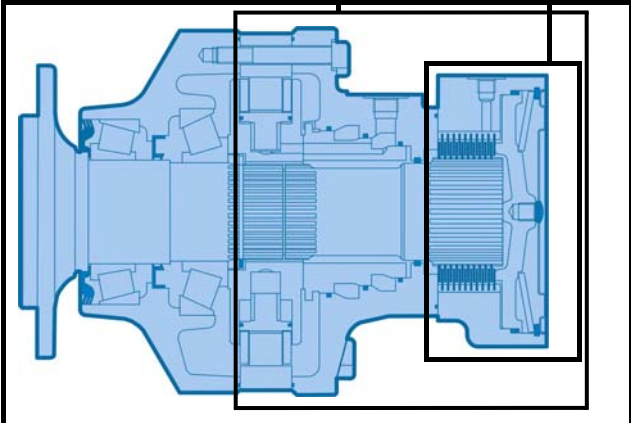

CONTENT

	MODULARITY	4	Modularity and Model code
	MODEL CODE	6	
	WHEEL MOTOR	9	Wheel motor
	Dimensions for standard (4311) 1-displacement motor	9	
	Dimensions for standard (4311) 2-displacement motor	9	
	Studs	10	
	Radial load and service life of bearings curves	11	
	SHAFT MOTOR	13	Shaft motor
	Dimensions for standard (3A51) 1-displacement motor	13	
	Dimensions for standard (3A51) 2-displacement motor	13	
	Coupling for male splines	14	
	Radial load and service life of bearings curves	15	
	VALVING SYSTEMS AND HYDROBASES	17	Valving systems and hydrobases
	Dimensions for 1-displacement valving	17	
	Dimensions for 2-displacement symmetrical valving	18	
	Chassis mountings	19	
	Hydraulic connections	20	
	Efficiency	21	
	Pressure drop and charge pressure	22	
	BRAKES	23	Brake
	Rear brake	23	
	INSTALLATION	25	Installation
	Torque arm mounting	25	
	Recommended torque arm design	25	
	OPTIONS	27	Options
	ACCESSORIES	31	Accessories
	Shrink disc	31	
	Anticavitation valve (VAC)	32	



MODULARITY

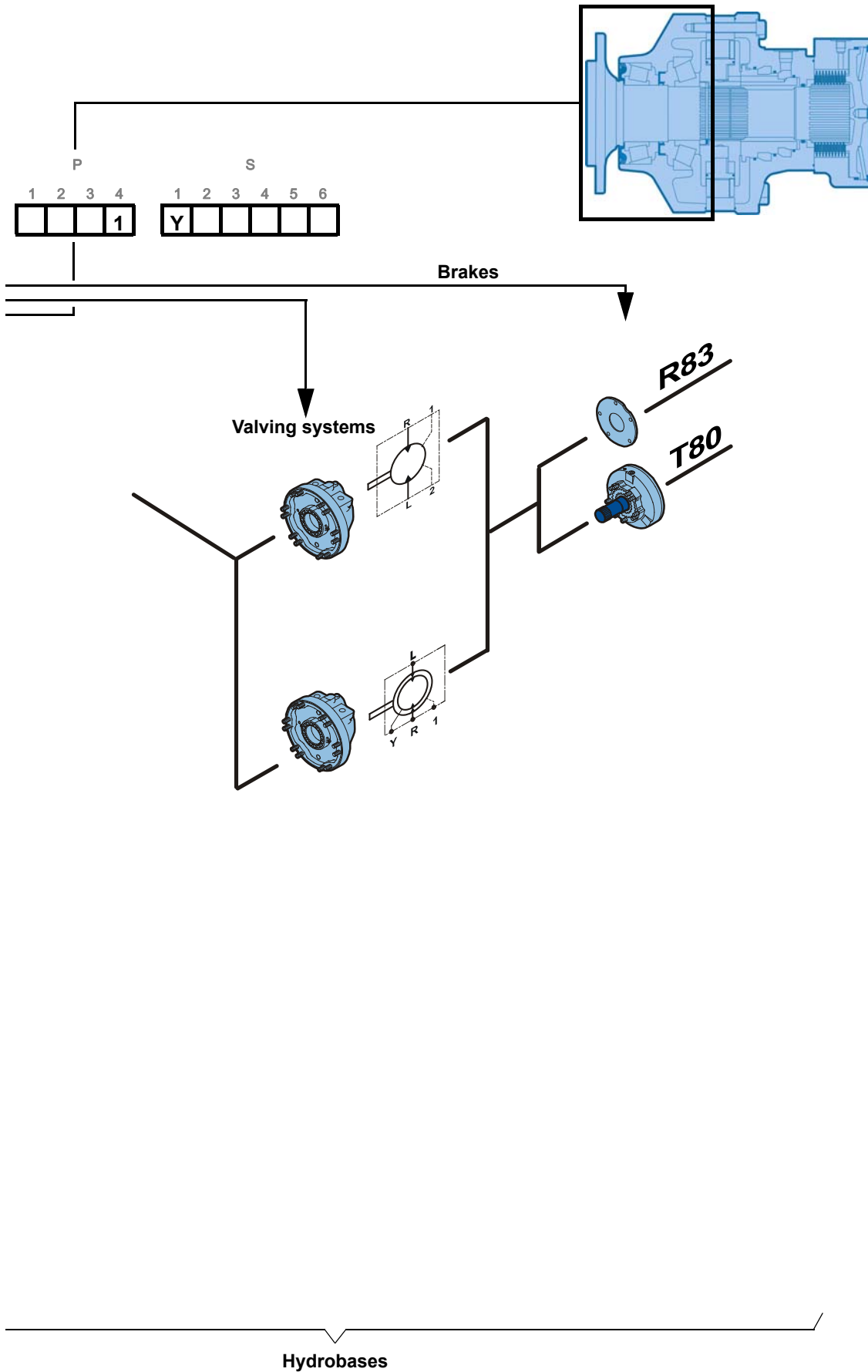

Modularity and Model code

- Wheel motor
- Shaft motor
- Valving systems and hydrobases
- Brake
- Installation
- Options
- Accessories



MODEL

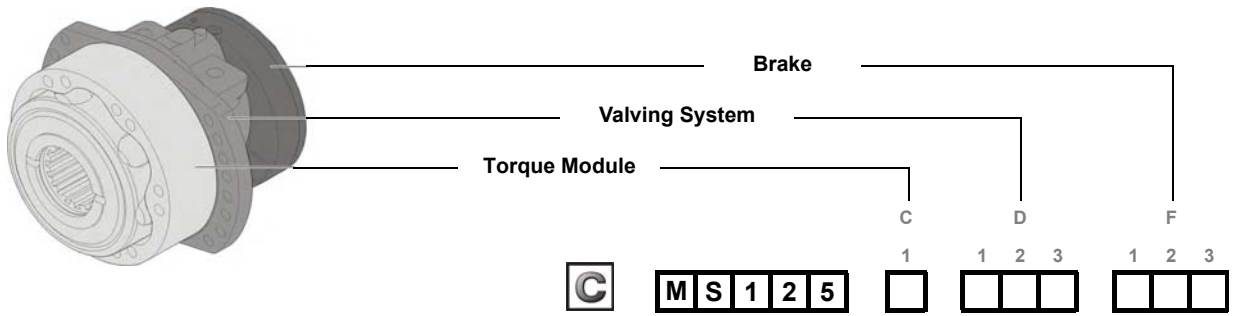

C1
Cam ring type

	1 displacement	2 displacements	
	cm ³ /tr [cu.in/rev.]		
Cams with equal lobes	10 000 [609.9]	5 000 [305.0]	8
	12 500 [762.4]	6 250 [381.2]	0
	15 000 [914.9]	7 500 [457.4]	2
Cams with unequal lobes		7 500 [457.4]	A
	12 500 [762.4]	5 000 [305.0]	

D3
Connection type

Without cover	0
HP: ISO 6162 (SAE flanges) DN 32 BP: ISO 9974-1 (Metric ports)	J
HP: ISO 6162 (SAE flanges) DN 32 BP: ISO 1179-1 (GAZ ports)	K

D1
Valving type

1-displacement valving		1
	Ratio 2	A
2-displacement symmetrical valving	Ratio <2	B
	Ratio >2	C

F1-F3
Rear brake

Brake (screwed environmental cover)	T 8 0
Without brake (reinforced plate)	R 8 3

D2
Valving cover

HighFlow™ distribution	Without mounting	B
	Lug fixing	C



CODE

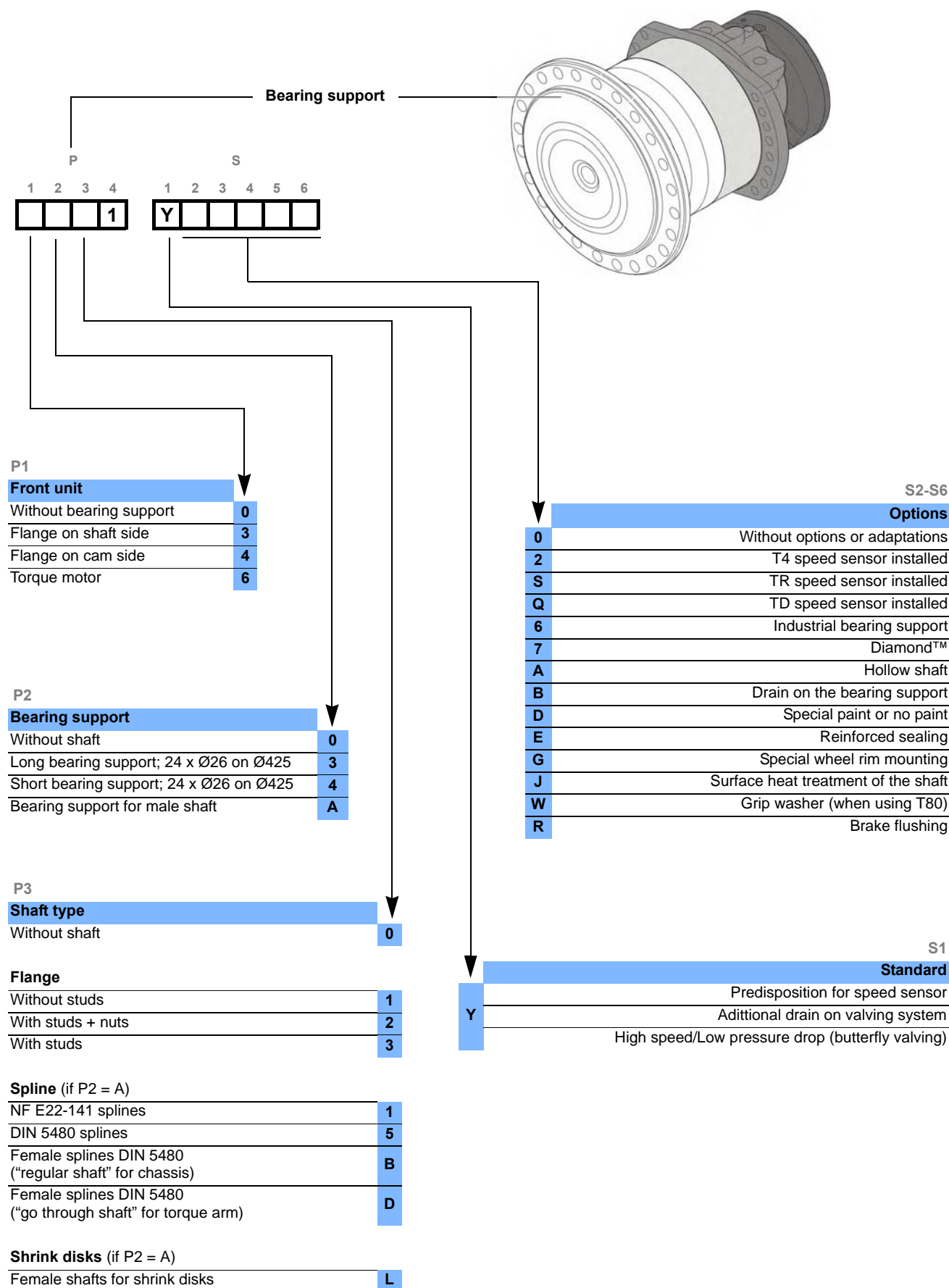



Methodology :

This document is intended for manufacturers of machines that incorporate Poclain Hydraulics products. It describes the technical characteristics of Poclain Hydraulics products and specifies installation conditions that will ensure optimum operation. This document includes important comments concerning safety. They are indicated in the following way:



Safety comment.

This document also includes essential operating instructions for the product and general information. These are indicated in the following way:



Essential instructions.



General information .



Information on the model number.



Weight of component without oil.



Volume of oil.



Units.



Tightening torque.



Screws.



Information intended for Poclain-Hydraulics personnel.

The views in this document are created using metric standards.
The dimensional data is given in mm and in inches (inches are given in brackets in italic)





WHEEL MOTOR

Dimensions for standard (4311) 1-displacement motor

	460 kg [1 012 lb]	563 kg [1 239 lb]
	11,00 L [660 cu.in]	9,00 L [540 cu.in]

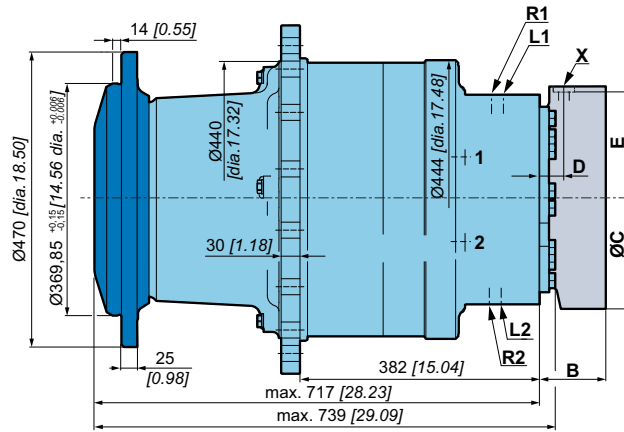
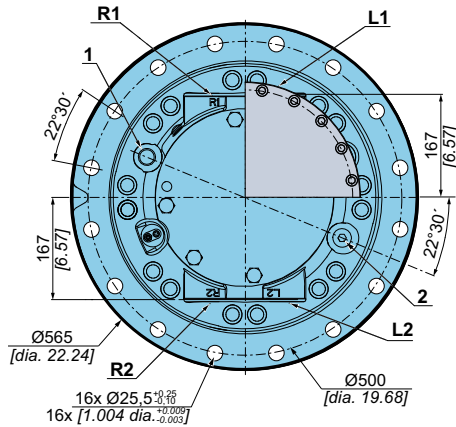

Dimensions for standard (4311) 2-displacement motor

For a small displacement, there is no preferred orientation for this motor.

	460 kg [1 012 lb]	563 kg [1 239 lb]
	11,00 L [660 cu.in]	9,00 L [540 cu.in]

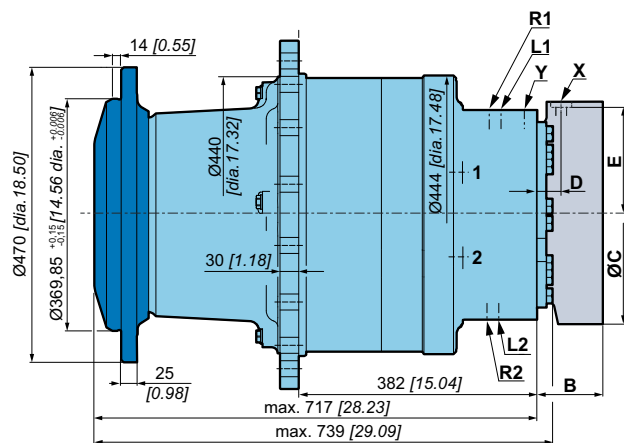
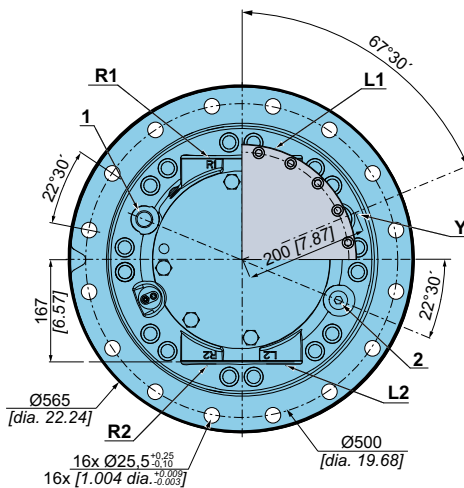

Also see 'Valving systems and hydrobases' section (thumbnail opposite).

	C	T 8 0
	B	189,0 [7,44]
	C	Ø376 [14,80 dia.]
	D	44,0 [1,73]
	E	181,0 [7,13]



Also see "Brake" section (thumbnail opposite).



For speed ≥ 90 rpm, the bearing support must be flushed: motor must be ordered with drain on the bearing support (option B).

Modularity and Model code

Wheel motor

Shaft motor

Valving systems and hydrobases

Brake

Installation

Options

Accessories



Support types

		C	D			F			P				S					
		1	1	2	3	1	2	3	1	2	3	4	1	2	3	4	5	6
		M	S	1	2	5						1						
C	A	B	C	D	E	N	Wheel rim mountings	L										
	mm [in]	mm [in]	mm [in]	mm [in]	mm [in]	mm [in]		mm [in]										
4 3 1 1	Ø 370	Ø 425	Ø 470	284	Ø 445	Ø 26	24 x M24x2	25										
<small>1 2 3 4</small>	[14,57 dia.]	[16,73 dia.]	[18,50 dia.]	[11,18]	[17,52 dia.]	[1,02 dia.]		[0,98]										
<small>P</small>																		
4 4 1 1	Ø 370	Ø 425	Ø 470	239	Ø 445	Ø 26	24 x M24x2	25										
<small>1 2 3 4</small>	[14,57 dia.]	[16,73 dia.]	[18,50 dia.]	[9,41]	[17,52 dia.]	[1,02 dia.]		[0,98]										
<small>P</small>																		

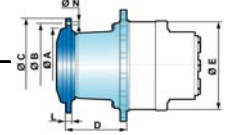

Studs

		P	C min.	C max.	D	Class
		mm [in]	mm [in]	mm [in]	mm [in]	
Studs	M24 x 2	95 [3,74]	5 [0,20]	39 [1,54]	30 [1,18]	12,9
		115 [4,53]		59 [2,32]		
Screws	M24 x 2	-	-	-	-	-

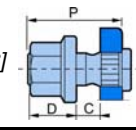

See generic installation motors N°B51352L.



Radial load and service life of bearings curves



The service life of the components is influenced by the pressure. You must check that the combination of forces applied (Axial load / Radial load) is compatible with the permissible loads for the components, and that the resulting service lives of these components complies with the application's specifications. For an accurate calculation, consult your Poclain Hydraulics application engineer.

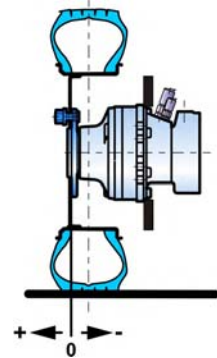

- Modularity and Model code
- Wheel motor
- Shaft motor
- Valving systems and hydrobases
- Brake
- Installation
- Options
- Accessories

Permissible radial loads

Max. permissible loads: 0 tr/min [0 RPM]; 0 bar [0 PSI].

Continuous permissible loads: > 0 tr/min [> 0 RPM]; 275 bar [3 988 PSI].

Test conditions: code 0 displacement, without axial load, shaft treated (option J), class 10.9 and 12.9 chassis mountings class 12.9 wheel rim mountings.

Service life of bearings

L : Millions B10 revolutions at 150 bars (average pressure), with 25 cSt fluid.

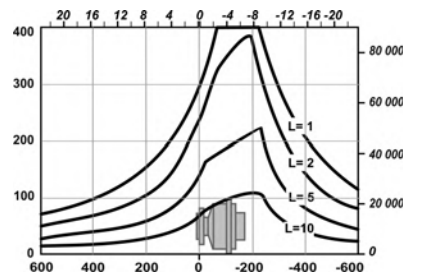
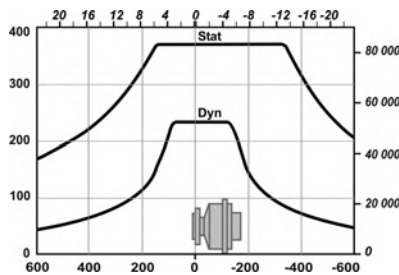
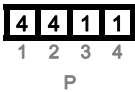
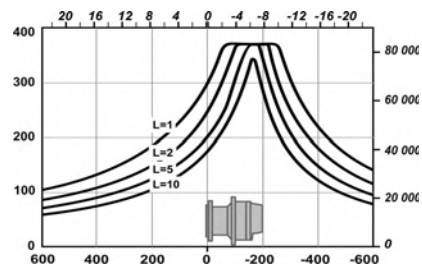
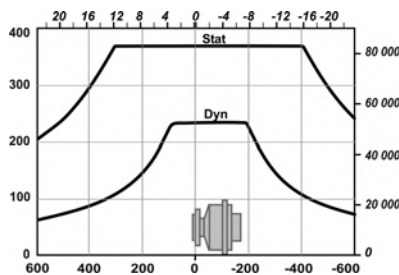
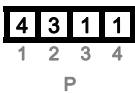





SHAFT MOTOR

Dimensions for standard (3A51) 1-displacement motor

	435 kg [957 lb]	585 kg [1 287 lb]
	11,00 L [660 cu.in]	9,00 L [540 cu.in]

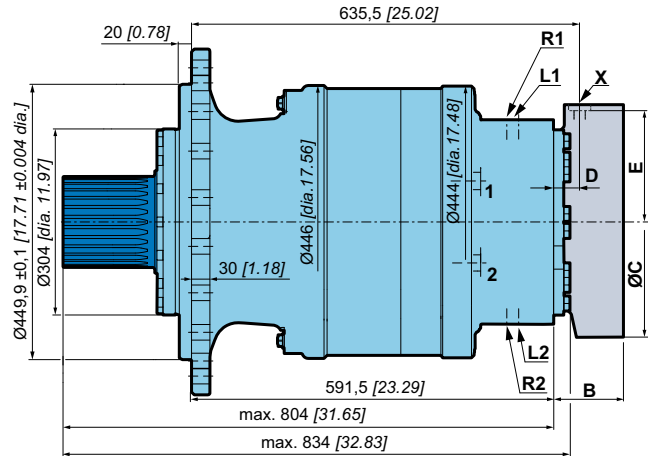
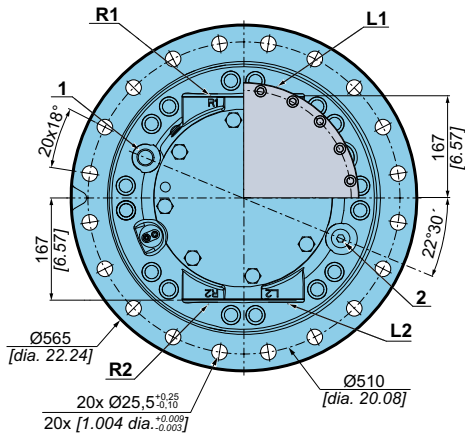

Dimensions for standard (3A51) 2-displacement motor

	435 kg [957 lb]	585 kg [1 287 lb]
	11,00 L [660 cu.in]	9,00 L [540 cu.in]

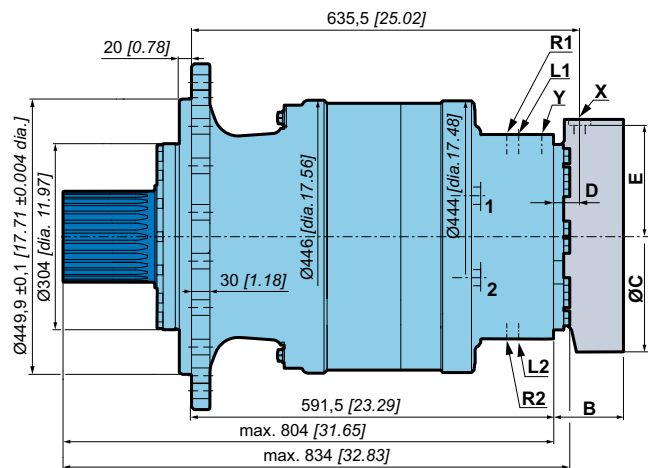
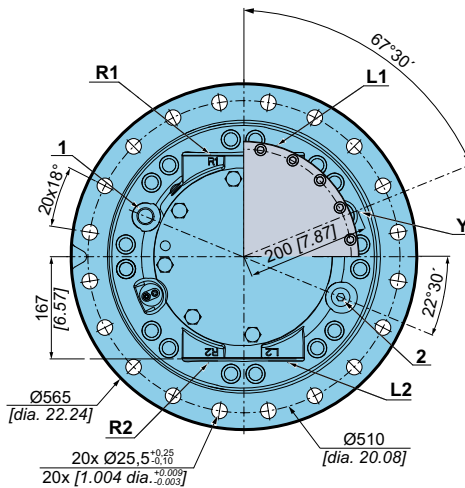

Also see 'Valving systems and hydrobases' section (thumbnail opposite).

	C	T 8 0
	B	189,0 [7,44]
	C	Ø376 [14,80 dia.]
	D	44,0 [1,73]
	E	181,0 [7,13]



Also see "Brake" section (thumbnail opposite).



For speed ≥ 90 rpm, the bearing support must be flushed: motor must be ordered with drain on the bearing support (option B).

- Modularity and Model code
- Wheel motor
- Shaft motor
- Valving systems and hydrobases
- Brake
- Installation
- Options
- Accessories



Support types

				C		D			F			P				S					
				1	2	1	2	3	1	2	3	1	2	3	4	1	2	3	4	5	6
M S 1 2 5																					
C				A	B	C	D	E	F	G											
				mm [in]	mm [in]	mm [in]	mm [in]	mm [in]	mm [in]	mm [in]											
NF E22-141 splines				40	R 4	60	2 x	31	150	-											
Nominal Ø 150 [5,91]				[1,57]	[R 0,16]	[2,36]	M16	[1,22]	[5,91]												
Module 3.75																					
Z 38																					
DIN 5480 splines				40	R 4	60	2 x	32	150	-											
Nominal Ø 150 [5,91]				[1,57]	[R 0,16]	[2,36]	M16	[1,26]	[5,91]												
Module 5																					
Z 28																					
6 D L 1				Ø 160	Ø 200	230	495	Ø 352	Ø 394	16 x											
				[6,30 dia.]	[7,87 dia.]	[9,06]	[19,49]	[13,86 dia.]	[15,51 dia.]	M24											
DIN 5480 splines				Ø 150	Ø 199	194	495	Ø 352	Ø 394	16 x											
Nominal Ø 150 [5,91]				[5,91 dia.]	[7,83 dia.]	[7,64]	[19,49]	[13,86 dia.]	[15,51 dia.]	M24											
Module 5																					
Z 28																					
DIN 5480 splines				Ø 150	Ø 199	194	495	Ø 352	Ø 394	16 x											
Nominal Ø 150 [5,91]				[5,91 dia.]	[7,83 dia.]	[7,64]	[19,49]	[13,86 dia.]	[15,51 dia.]	M24											
Module 5																					
Z 28																					

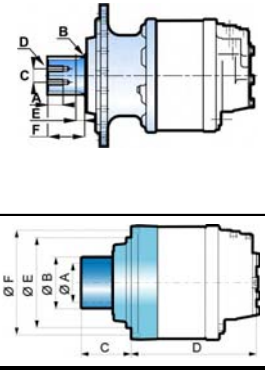

Coupling for male splines

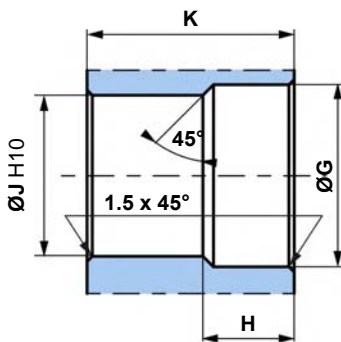

Standard DIN 5480
 Pressure angle 30°.
 Centering on flanks.
 Slide fit (7H quality).

N : Nominal Ø.
Mo : Module.
Z : Number of teeth.

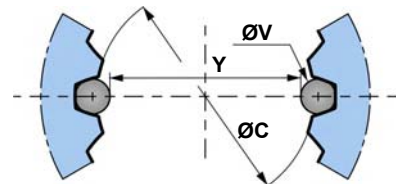

				Ø G	H	Ø J	K	N	Mo	Z	Offset	Ø C (H10)	Ø V	Y	Tolerance (Y)
				mm [in]	mm [in]	mm [in]	mm [in]	mm [in]			mm [in]	mm [in]	mm [in]	µm [µin]	
C															
3 A 5 1				152	33	140	149	150	5	28	2,25	140	9	131,104	+ 87 / 0
				[5,98]	[1,30]	[5,51]	[5,87]	[5,91]			[0,0886]	[5,51]	[0,35]	[5,16]	[+3.425 / 0]

General tolerances : ± 0.25 [±0.0098].

Material: Ex: 42CrMo4.

Hardening treatment to obtain R = 800 to 900 N/mm² [R = 116 030 to 130 533 PSI].



Coupling for shrink discs

C	A mm [in]	B mm [in]	C mm [in]	D mm [in]
6 D L 1	Ø 160 [6,30 dia.]	140 [5,51]	10 [0,394]	0,5 [0,0197]

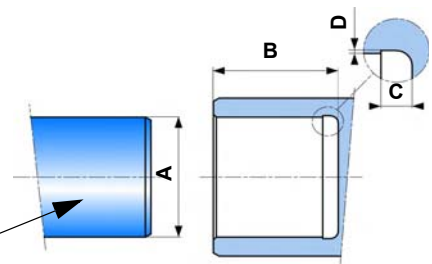

R min. : 640 N/mm² [132 800 PSI]

Radial load and service life of bearings curves

Permissible radial loads

Max. permissible loads: 0 tr/min [0 RPM]; 0 bar [0 PSI].

Continuous permissible loads: > 0 tr/min [> 0 RPM]; 275 bar [3 988 PSI].

Service life of bearings

L : Millions B10 revolutions at 150 bars (average pressure), with 25 cSt fluid.

Test conditions: code 0 displacement, without axial load, shaft treated (option J), class 10.9 and 12.9 chassis mountings.

3 A 1 1
3 A 5 1

1 2 3 4
P

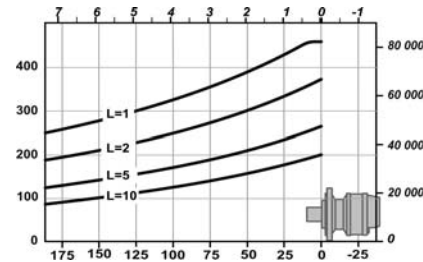
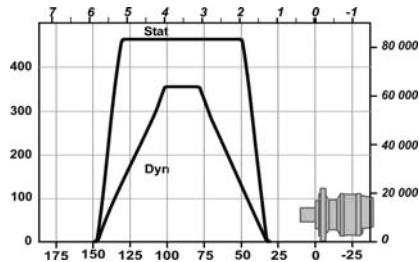

6 D L 1
6 A B 1
6 A D 1

1 2 3 4
P

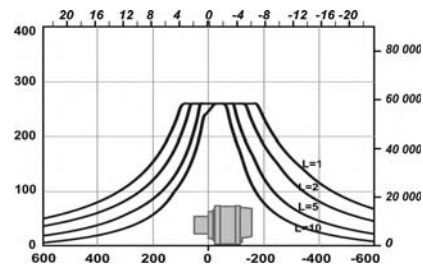
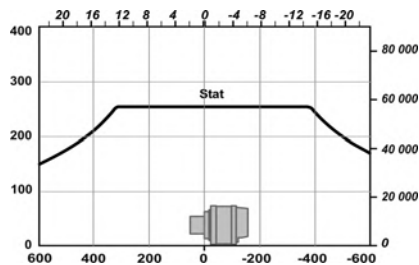

The service life of the components is influenced by the pressure. You must check that the combination of forces applied (Axial load / Radial load) is compatible with the permissible loads for the components, and that the resulting service lives of these components complies with the application's specifications. For an accurate calculation, consult your Poclain Hydraulics application engineer.

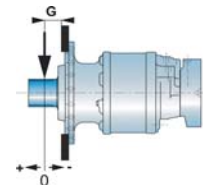

C	G mm [in]
3 A 1 0	151 [5,94]
3 A 5 0	151 [5,94]
6 D L 0	65,75 [2,589]
6 A B 0	65,75 [2,589]
6 A D 0	65,75 [2,589]

- Modularity and Model code
- Wheel motor
- Shaft motor
- Valving systems and hydrobases
- Brake
- Installation
- Options
- Accessories



Coupling for female splines

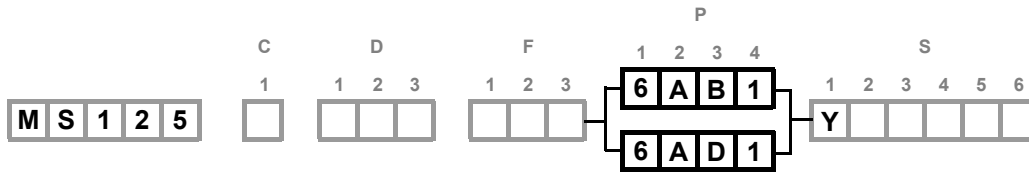

Splined DIN 5480
 Pressure angle: 30°
 Nominal diameter: 150
 Number of Teeth: 28
 Modulus: 5
 Tolerance class:8

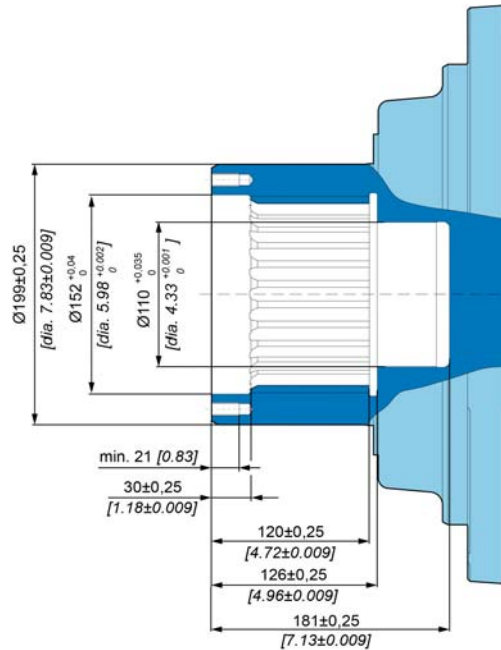

Recommended customer shaft design to be used with bearing support 6AB1 or 6AD1.

	Torque arm motor	Flange mounted motor
A ⁽¹⁾	Ø110 [4,33 dia.]	Ø110 [4,33 dia.]
B ⁽²⁾	Ø152 [5,98 dia.]	Ø152 [5,98 dia.]
C	DIN 5480 W150 x 5 30 x 26 x 8f	
E	10,0 [0,39]	5,0 [0,20]
F	98,0 [3,86]	98,0 [3,86]
G	58,0 [2,28]	55,0 [2,17]
LU	99,0 [3,90]	99,0 [3,90]

(1) - 0.012 [-0.0004]
 - 0.034 [- 0.001]

(2) - 0.114 [+0.004]
 - 0.139 [- 0.005]

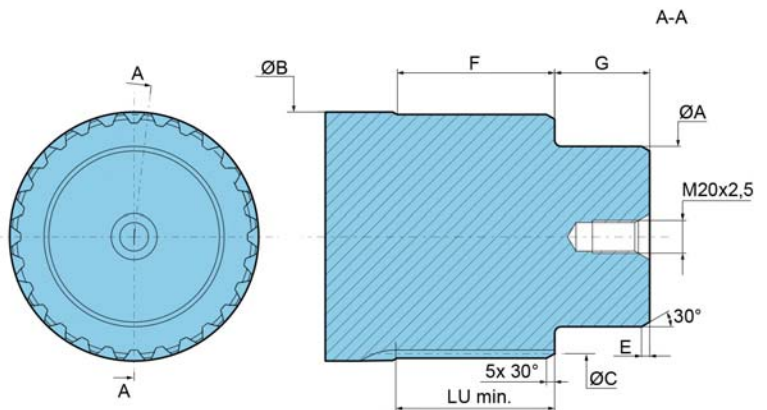

For torque arm mounting, use bearing support 6AD1. Both motor and customer shaft must be in axial contact (no axial play) and must have sealing between motor and customer shaft.



For chassis mounting, use bearing support 6AB1. An axial play must be ensured between motor and customer shaft.



Consult your Poclair Hydraulics application engineer.



VALVING SYSTEMS AND HYDROBASES



Dimensions for 1-displacement valving

	301 kg [662 lb]	399 kg [878 lb]
	4,50 L [270 cu.in]	4,00 L [240 cu.in]

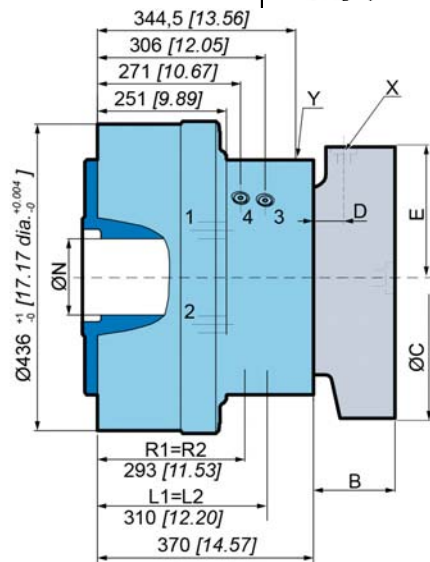
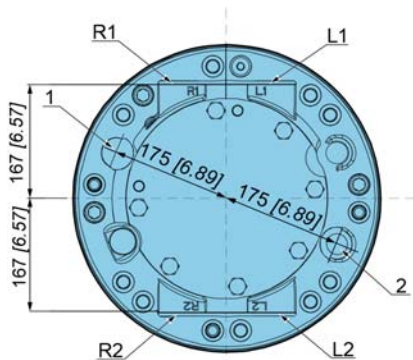

	T 8 0
B	189,0 [7,44]
C	Ø376 [14,80 dia.]
D	44,0 [1,73]
E	181,0 [7,13]

Also see "Brake" section (thumbnail opposite).

Cylinder block splines

(as per standard DIN 5480)

ØN	Module	Z	Dimension on 2 pins			C
			Y	ØV	ØF ⁽¹⁾	
130 [5,118]	3	42	119,078 [4,688]	5,25 [0,207]	124,025 [4,883]	1

(1) +0,025 [+0,001]
+0,025 [+0,001]

You are advised to have the installation validated by your Poclain Hydraulics application engineer before using the hydraulic unit in an application.

We must provide you with a detailed plan of the interface for any hydraulic unit use, consult your Poclain Hydraulics sales engineer.

- Modularity and Model code
- Wheel motor
- Shaft motor
- Valving systems and hydrobases
- Brake
- Installation
- Options
- Accessories



Dimensions for 2-displacement symmetrical valving

For a small displacement, there is no preferred orientation for this motor.

	301 kg [662 lb]	399 kg [878 lb]
	4,50 L [270 cu.in]	4,00 L [240 cu.in]

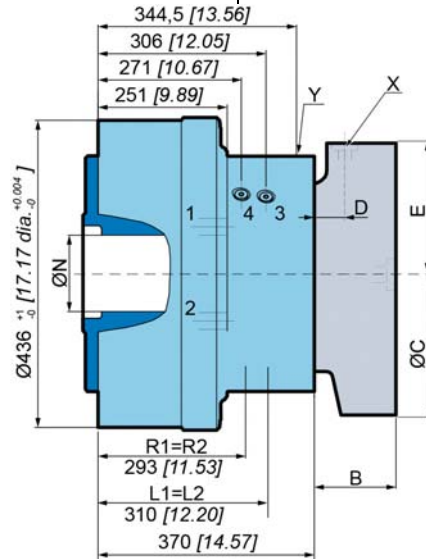
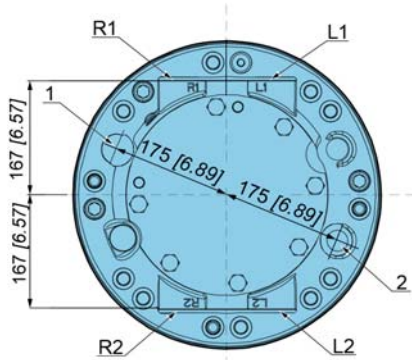

	C	T 8 0
B	189,0 [7,44]	
C	Ø376 [14,80 dia.]	
D	44,0 [1,73]	
E	181,0 [7,13]	



Also see "Brake" section (thumbnail opposite).

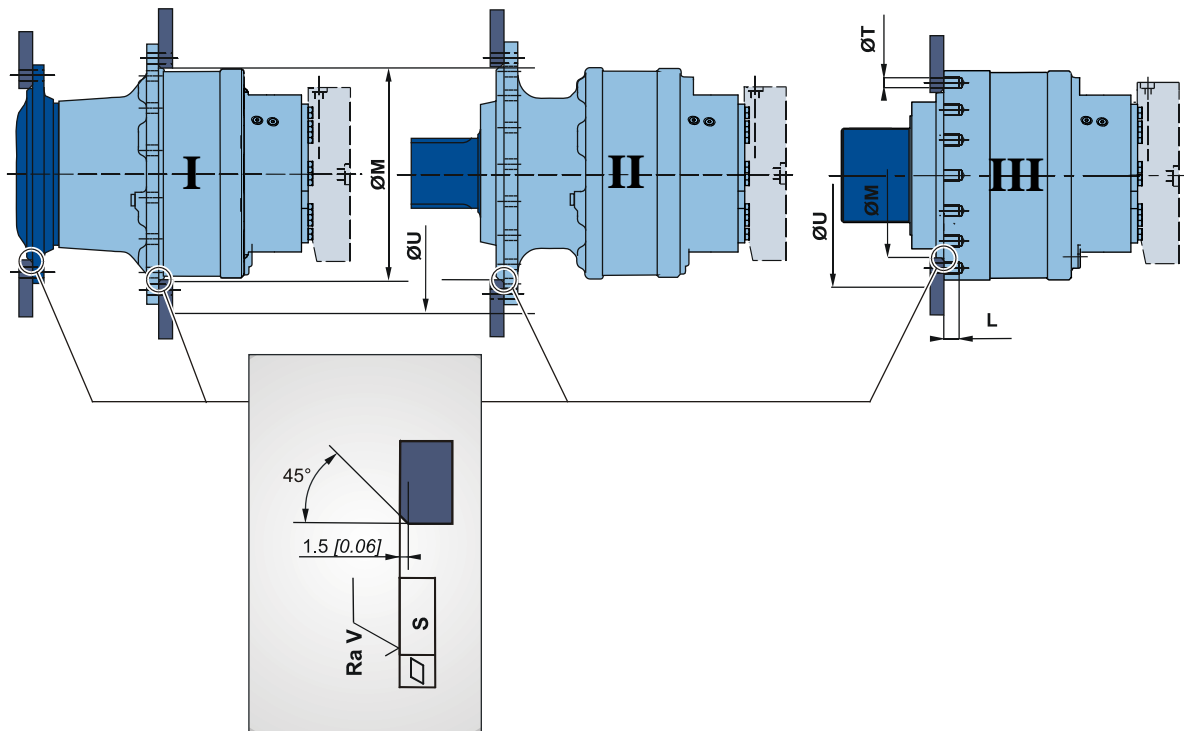

Chassis mountings



Take care over the immediate environment of the connections.

	ØM ⁽¹⁾ mm [in]	ØU mm [in]	ØT mm [in]	L mm [in]	S mm [in]	Ra V µm [µin]		Class	 * N.m [lb.ft]
I	450 [17,72]	565 [22,24]	-	-	0,2 [0,008]	12,5 [0,49]	16 x M24	12,9	1 200 [885,1]
II							20 x M24		
III	352 [13,86]	446 [17,56]	25,5 [1,004]	35 [1,378]	16 x M20	1200 [885,1]			

(1) +0,3 [+0,012]
+0,2 [+0,008]

* : Min. values for torque and load to be transmitted.

- Modularity and Model code
- Wheel motor
- Shaft motor
- Valving systems and hydrobases
- Brake
- Installation
- Options
- Accessories



Hydraulic connections

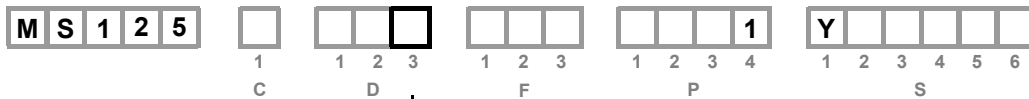
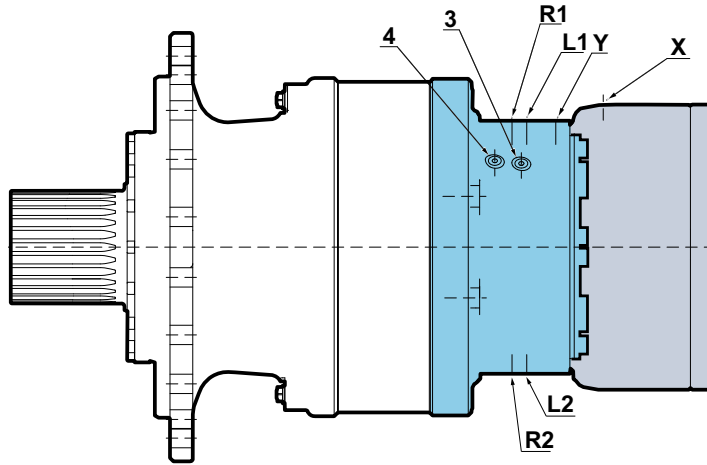

		Standards	Power supply	Case drain	2 nd displacement control	Pressure measurement points	Control of parking brake
			R-L	1, 2		3, 4	X
	J	Metric	ISO 9974-1	M27x2		M14x1.5	M18x1.5
	K	Gaz (BSPP)	ISO 1179-1	BSP 3/4		BSP 1/4	BSP 3/8
			R-A	1, 2	Y	3, 4	X
	J	Metric	ISO 9974-1	M27x2	M18x1.5	M14x1.5	M18x1.5
	K	Gaz (BSPP)	ISO 1179-1	BSP 3/4	BSP 3/8	BSP 1/4	BSP 3/8
Max. pressure		MS bar [PSI]	450 [6 527]	1 [15]	30 [435]	450 [6 527]	30 [435]



You are strongly advised to use the fluids specified in brochure "Installation guide" N° B61352L.



To find the connections' tightening torques, see the brochure "Installation guide" N° B61352L.



Efficiency

Overall efficiency

Average values given for guidance for code 0 displacement after 100 hours of operation with HV46 hydraulic fluid at 50°C [122°F].

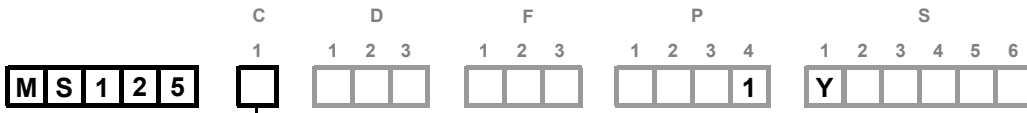
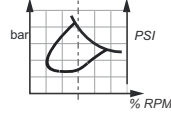

8

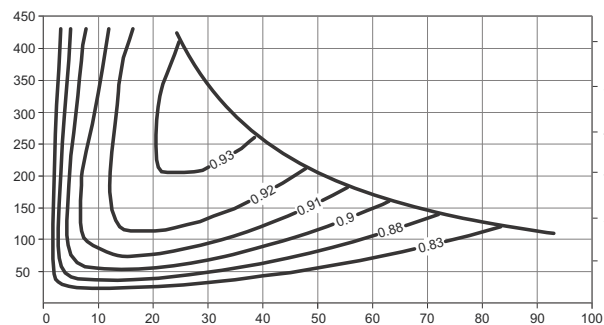

0

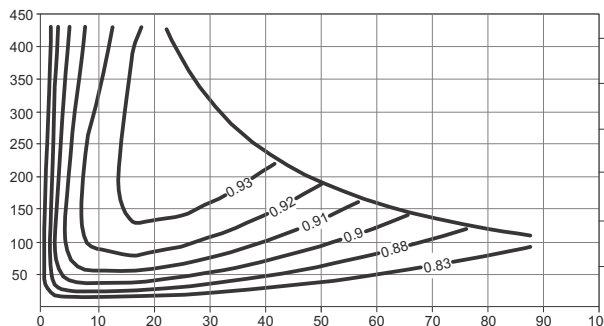

2

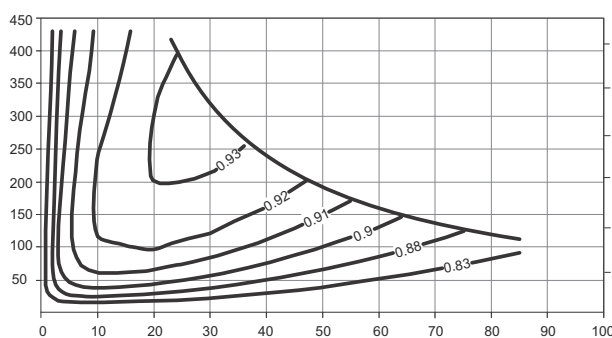

For a precise calculation, consult your Poclair Hydraulics application engineer.

Modularity and Model code

Wheel motor

Shaft motor

Valving systems and hydrobases

Brake

Installation

Options

Accessories



Pressure drop and charge pressure

Pressure drop (With HV46 hydraulic fluid at 50 °C [122 °F], oil viscosity 30 cSt)

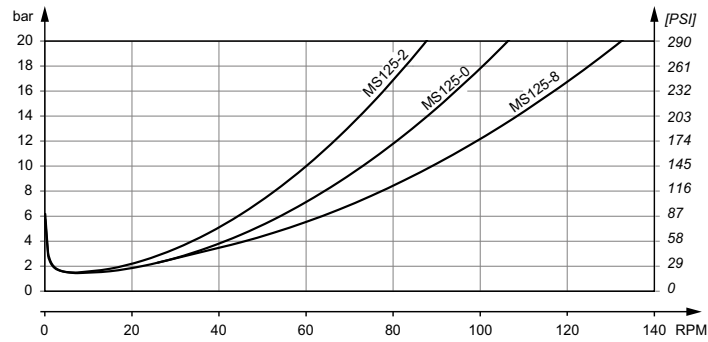

Charge pressure (With HV46 hydraulic fluid at 50 °C [122 °F], oil viscosity 30 cSt)

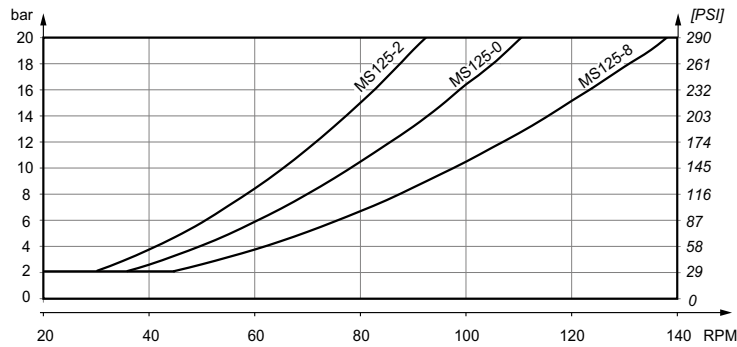

Pressure drop and charge pressure curves are corresponding to 1st displacement motor.



BRAKES

Rear brake

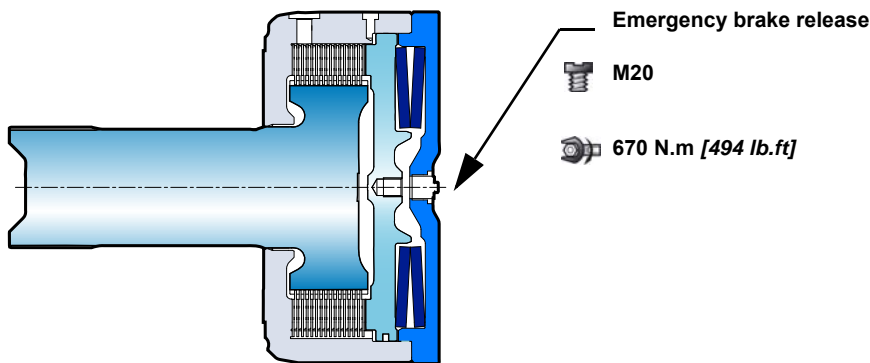
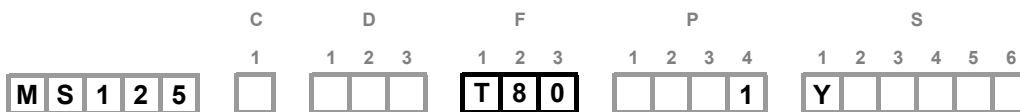

Brake principle

This is a multidisc brake which functions through the absence of pressure. The spring exerts a force on the piston, which acts on the fixed and mobile discs, and thus immobilizes the shaft. The braking torque decreases in linear proportion to the brake release pressure.

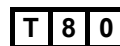

Parking brake information

Parking brake torque at 0 bars on housing (new brake)	72 000 Nm [53 100 lb.ft]
Dynamic emergency braking torque at 0 bars on housing (max. 10 uses of emergency brakes)	62 400 Nm [46 020 lb.ft]
Residual parking braking at 0 bars on housing (After emergency brake has been used)	54 000 Nm [39 830 lb.ft]
Min. brake release pressure	20 bar [290 PSI]
Max. brake release pressure	30 bar [435 PSI]
Oil capacity	450 cm ³ [27,5 cu.in]
Volume for brake release	135 cm ³ [8,2 cu.in]

Dynamic brake information

T80 negative brake, along with option R, can be also used as dynamic brake under specific conditions. See page 29 for more information.



Do not run-in the multidisc brakes.



A functional check of the parking brake must be carried out each time it is used as an auxiliary brake (or emergency brake). For all vehicles capable of speeds over 25 km/h, please contact your Poclair Hydraulics application engineer.

- Modularity and Model code
- Wheel motor
- Shaft motor
- Valving systems and hydrobases
- Brake
- Installation
- Options
- Accessories





INSTALLATION

Torque arm mounting

We recommend a length of the torque arm of 800 mm [31.5 in].
 In order to avoid residual forces due to misalignment and twisting, the end of the arms must retain freedom of movement in 2 axis.

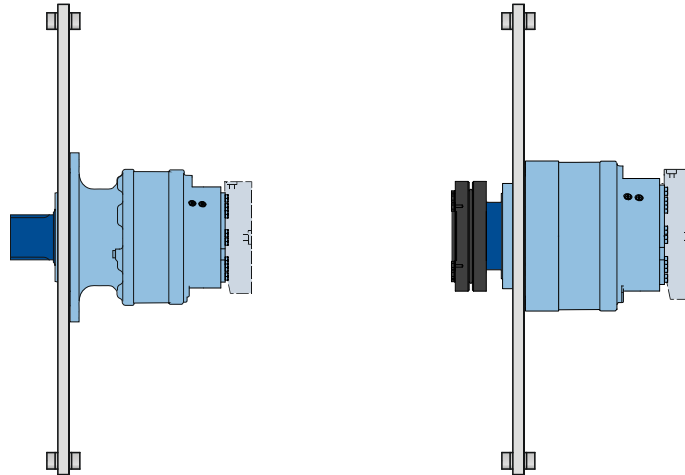

Recommended torque arm design

Torque arm can be supplied by Poclain Hydraulics. It must be ordered separately.

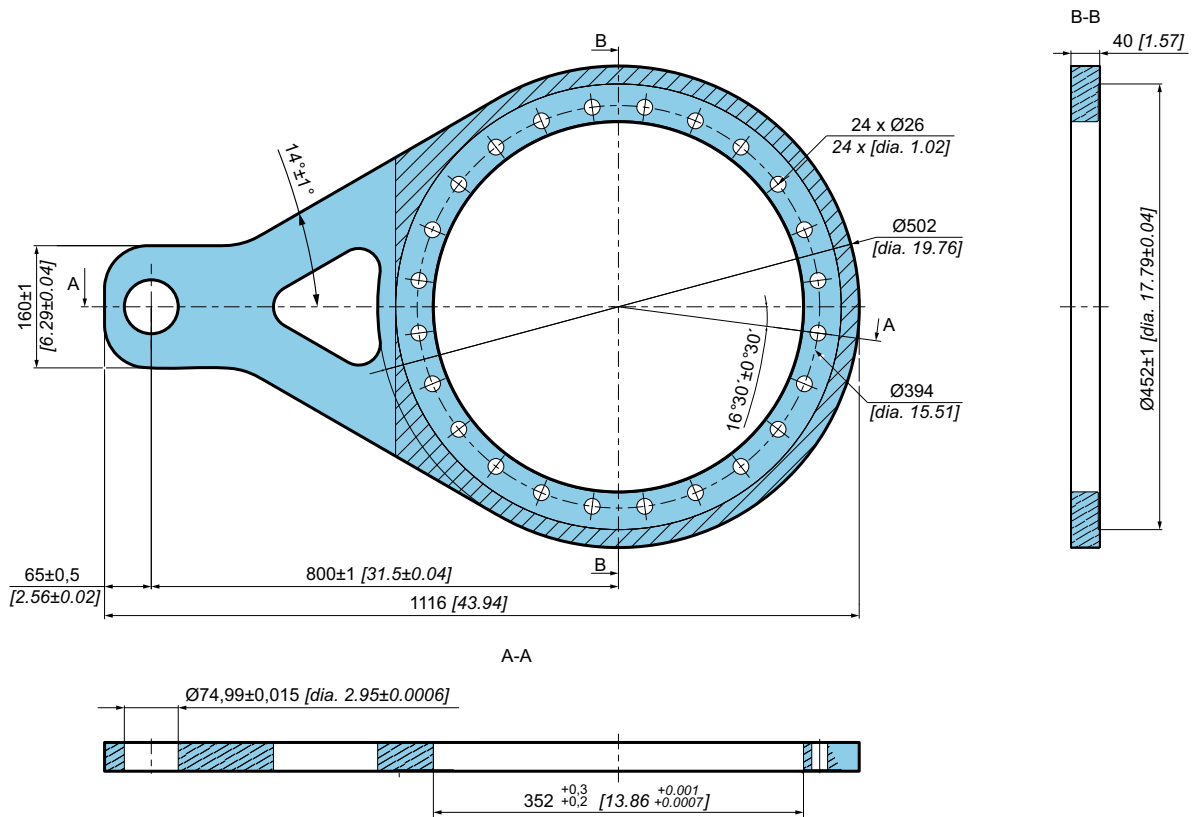

For a precise calculation, consult your Poclain Hydraulics application engineer.

- Modularity and Model code
- Wheel motor
- Shaft motor
- Valving systems and hydrobases
- Brake
- Installation
- Options
- Accessories





OPTIONS

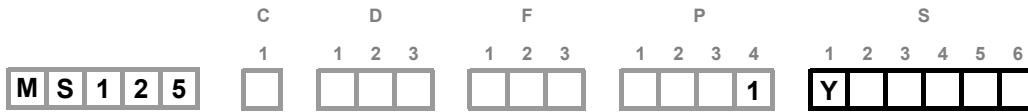

You can accumulate more than one optional part. Consult your Poclain Hydraulics sales engineer.

Y - Standard option

Designation

Predisposition for speed sensor

Additional drain on valving system

High speed/Low pressure drop (Butterfly valving)



Y

2 - S - Q Installed speed sensor

Designation

T4 Speed sensor (without rotation direction)

TR Speed sensor (digital rotation direction)

TD speed sensor (two phase shifted frequencies)



2

S

Q

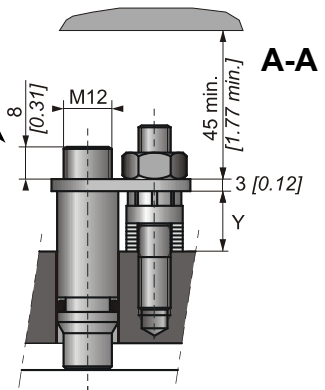
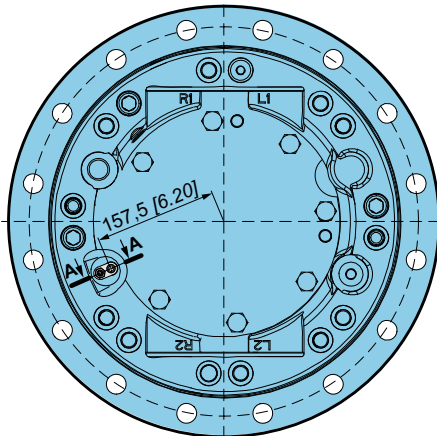

Max. length Y= 14.8

Standard number of pulses per revolution= 60



Look at the "Mobile Electronic" N° A01889D technical catalogue for the sensor specifications and its connection.



To install the sensor, see the "Installation guide" brochure No. B61352L.

Modularity and Model code

Wheel motor

Shaft motor

Valving systems and hydrobases

Brake

Installation

Options

Accessories



6 - Industrial support

Reduction of around 50% from the rated value in the bearings' preload value.



For a precise calculation, consult your Poclain Hydraulics application engineer.

7 - Diamond™

Special treatment of the motor core which considerably increases its strength, making the motor much more tolerant to temporary instances of the operating conditions being exceeded.

A - Hollow shaft

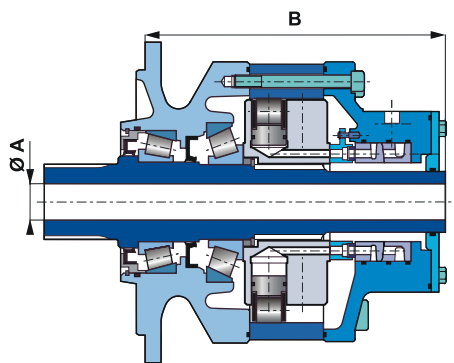

A	B
mm [in]	mm [in]
Ø 75 [2,95 dia.]	634 [24,97]

Radial load x 0.75
No torque transmittable to the rear

B - Drain on the bearing support

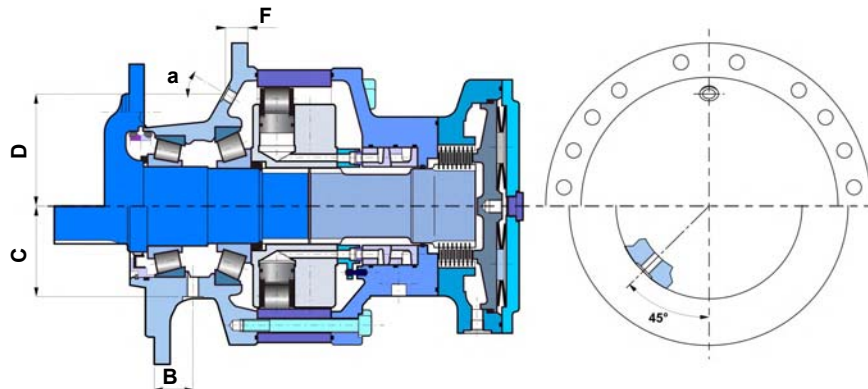

	B	C	D	F	a
	mm [in]	mm [in]	mm [in]	mm [in]	
Shaft motor	-	-	173 [6,81]	40 [1,57]	36°
Wheel motor	70 [2,76]	185 [7,28]	-	-	-

D - Special paint or no paint

The motors are delivered with Poclain Hydraulics yellow ochre primer as standard.



Consult your Poclain Hydraulics application engineer for other colors of primer or topcoat.



E - Reinforced sealing

Requires reinforced seals and, for an unbraked motor, a rear reinforced plate (**R83** - 15 [0.594] thick, instead of 6 [0.237]).

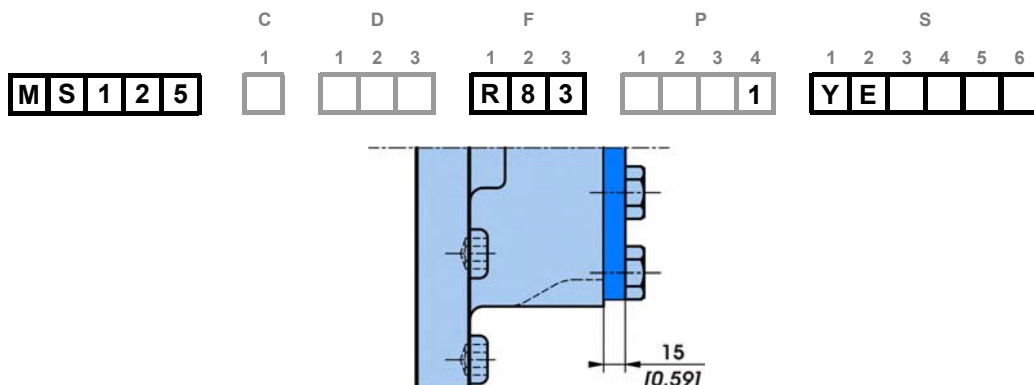

G - Special wheel rim mounting

Enables certain combinations different from the standard mountings defined on page 10.

Consult your Poclair Hydraulics sales engineer.

J - Treated shaft

Heat treatment on the indicated bearing radius and splines.

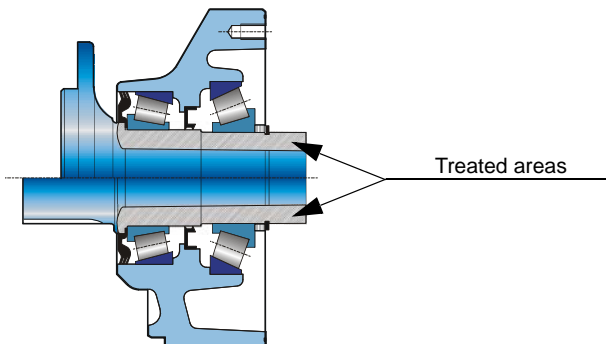

W - Grip washer

Mandatory for T80 brake (page 23).

R - Brake flushing

T80 negative brake, along with option R for brake flushing, can be used as dynamic brake under specific conditions.

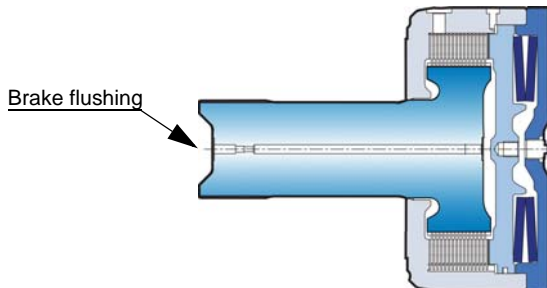

Min. internal irrigation flow rate (at 20 bar brake release pressure)	1,7 L/min [0,45 gal/min]
Max. internal irrigation flow rate (at 30 bar brake release pressure)	3,1 L/min [0,82 gal/min]

Consult your Poclair Hydraulics application engineer.

- Modularity and Model code
- Wheel motor
- Shaft motor
- Valving systems and hydrobases
- Brake
- Installation
- Options
- Accessories







ACCESSORIES

Shrink disc

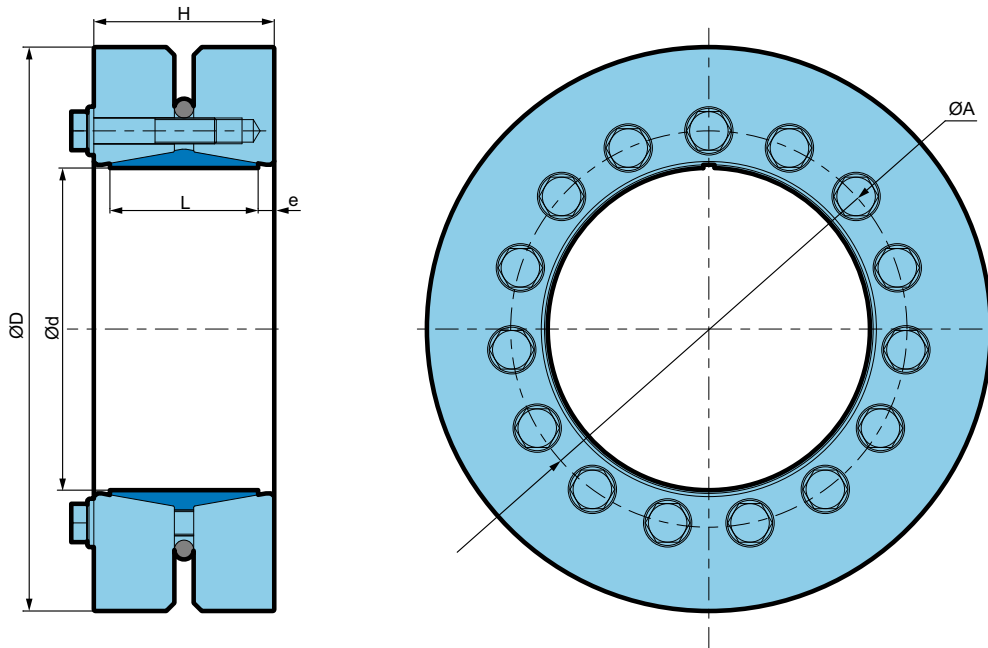
Shrink disc can be supplied for motor MS125 using bearing support 6AL1.



d	D	H	L	e	A		Mt-max	
mm [in]	mm [in]	mm [in]	mm [in]	mm [in]	mm [in]		Nm [lbf]	kg [lbs]
200 [7,87]	350 [13,78]	112 [4,41]	92 [3,62]	10 [0,39]	246 [9,69]	15x M16x80	110 000 [81 100]	51 [112]

- Modularity and Model code
- Wheel motor
- Shaft motor
- Valving systems and hydrobases
- Brake
- Installation
- Options
- Accessories

**Anticavitation valve (VAC)**

- Flanged on MS125 flat ports
- Protect motor against cavitation risk
- Available with two positions of accumulator

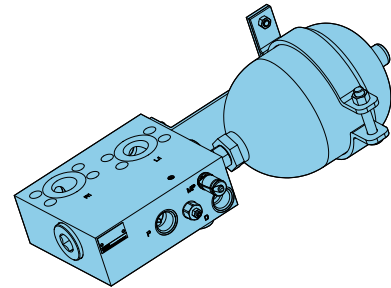
**Description**

This valve, which is directly flanged on the MS125, will offer enhanced protection of the motor against possible cavitation during operation, by ensuring sufficient back pressure on the motor (additional flow provided by the accumulator).

Accumulator only available in 0° position.

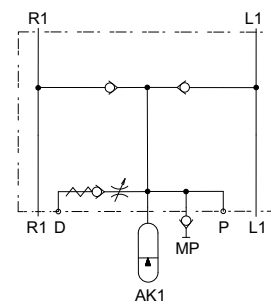
Hydraulic symbol**Features**

Max. pressure	bar [PSI]	450 [6 526]
Fluid viscosity	mm ² /s [ssu]	15 to 380 [69.5 to 1 760]
Required fluid filtration	ISO 4406	18/16/13
Surface protection	DIN 50979	Fe/ZN8/Cn/T2

Accumulator

Precharge pressure	bar [PSI]	12 [174]
Volume	l [GPM]	2 [0.53]

Hydraulic connections

Port	Function	Connections		Max. pressure bar [PSI]
		GAZ ISO 1179-1	ISO 6162-2	
P	Pressure line	G3/4	-	30 [435]
D	Drain			30 [435]
L1	Motor line - L1	-	PN400 DN32	450 [6 526]
R1	Motor line - R1			450 [6 526]



Pressure drop

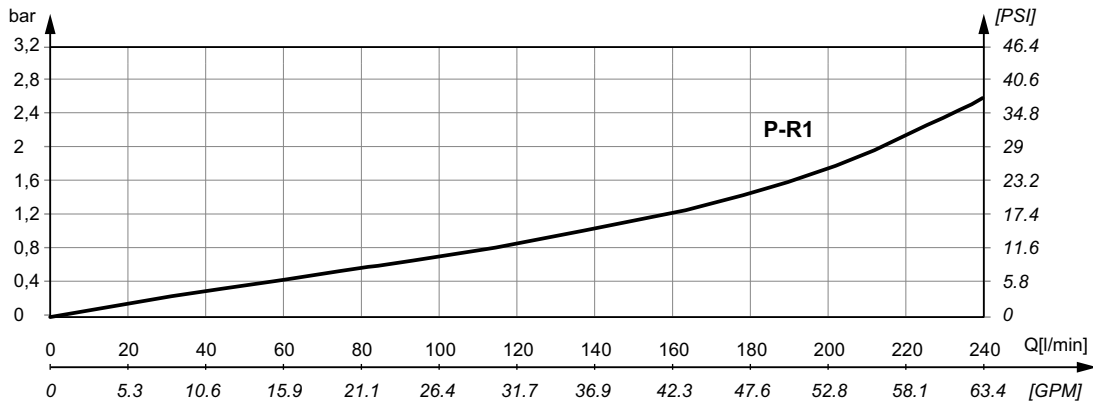
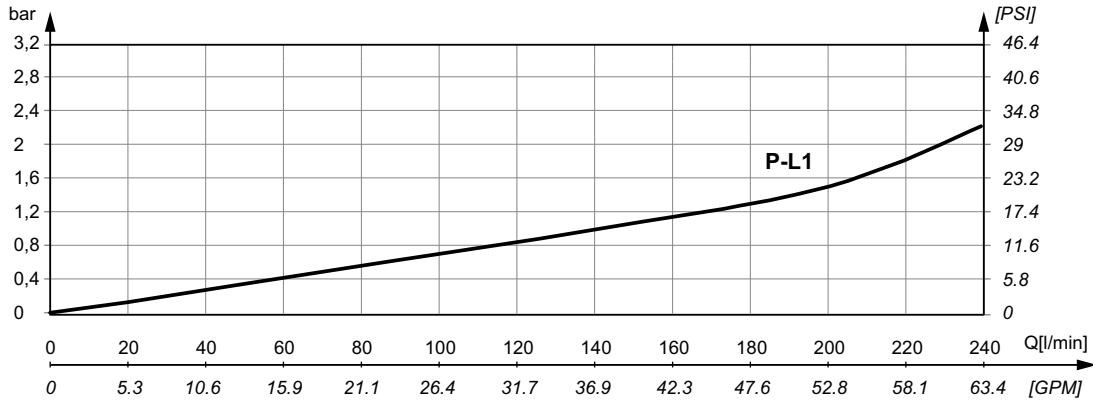

Dimensions

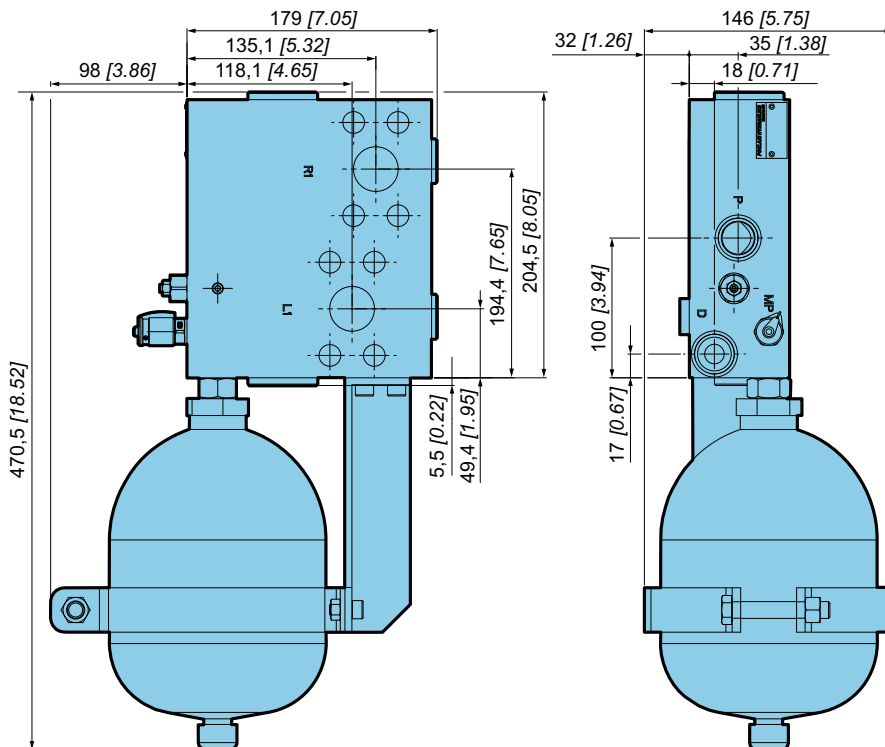

- Modularity and Model code
- Wheel motor
- Shaft motor
- Valving systems and hydrobases
- Brake
- Installation
- Options
- Accessories





Modularity and
Model code

Wheel motor

Shaft motor

Valving systems
and hydrobases

Brake

Installation

Options









Accessories



Poclain Hydraulics reserves the right to make any modifications it deems necessary to the products described in this document without prior notification. The information contained in this document must be confirmed by Poclain Hydraulics before any order is submitted.

Illustrations are not binding.

The Poclain Hydraulics brand is the property of Poclain Hydraulics S.A.

-  28/02/2020
-  801 478 126J
-  801 478 196K
-  801 578 109L
-  801 578 121Z
-  801 578 133M
-  A50155R
-  Not available
-  A14248M

